



# RADIATOR VALVES

**giacotech series**



Technical documentation

0157EN

## SOMMARIO

1 **APPLICATIONS**

2 **MICROMETRIC THERMOSTATIC VALVES**



7 **THERMOSTATIC VALVES**



13 **MANUAL VALVES**



15 **LOCKSHIELDS**



19 **ACCESSORIES AND SPARE PARTS**



## APPLICATIONS

Constantly focused on the market and on the growing needs in terms of user-friendliness and reliability of the system, Giacomini proposes the Giacotech valves and lockshields range. This family represents the evolution and implementation of the well-known and successful Programma 80 that, with its functional innovative characteristics (the thermostatic element and the pipe union with self-sealing element in plastic material) imposed itself on the market from 1979 on. Today Giacotech comes out as legitimate successor, with a new version, enhanced both in the range and in the technical aspects. Unlike the well-known and successful Programma 80, the most recent Giacotech series consists of a wider range including micrometric thermostatic valves as well as the basic thermostatic valves, manual valves and lockshields, all are both in the versions with iron connection and with adaptor connection. This way the installer can easily choose within the Giacotech series with the safety of finding and using something as close as possible to one's needs.

Programma 80, introduced on the Italian market in 1979, was successful thanks to its functional innovative characteristics, such as the thermostatic element (without the help of any accessories) and the presence of a pipe union with a self-sealing element in plastic material. During the years the work of the installer became easier and this is one of the basic aspects for Giacomini. Within the Giacotech series the main aspects are:

- Introduction of a self-sealing element in elastomeric material, the natural evolution of the self-sealing in plastic material featured by Programma 80
- Unification of the adaptor for the mostly used sizes
- Restyling of operation hand wheels of micrometric thermostatic valves
- Introduction of building yard protections to prevent accidental damage to operation handwheels during the installation.



## MICROMETRIC THERMOSTATIC VALVES

### Micrometric adjustment

The series of micrometric thermostatic valves Giacotech features, in addition to a more comfortable operation handle and a series of parameters already widely described in the introduction, and the possibility of making the micrometric adjustment through which it is possible to separate the opening of the valve operating in manual. Removing the upper part of the handwheel access to the graduation scale is easy.

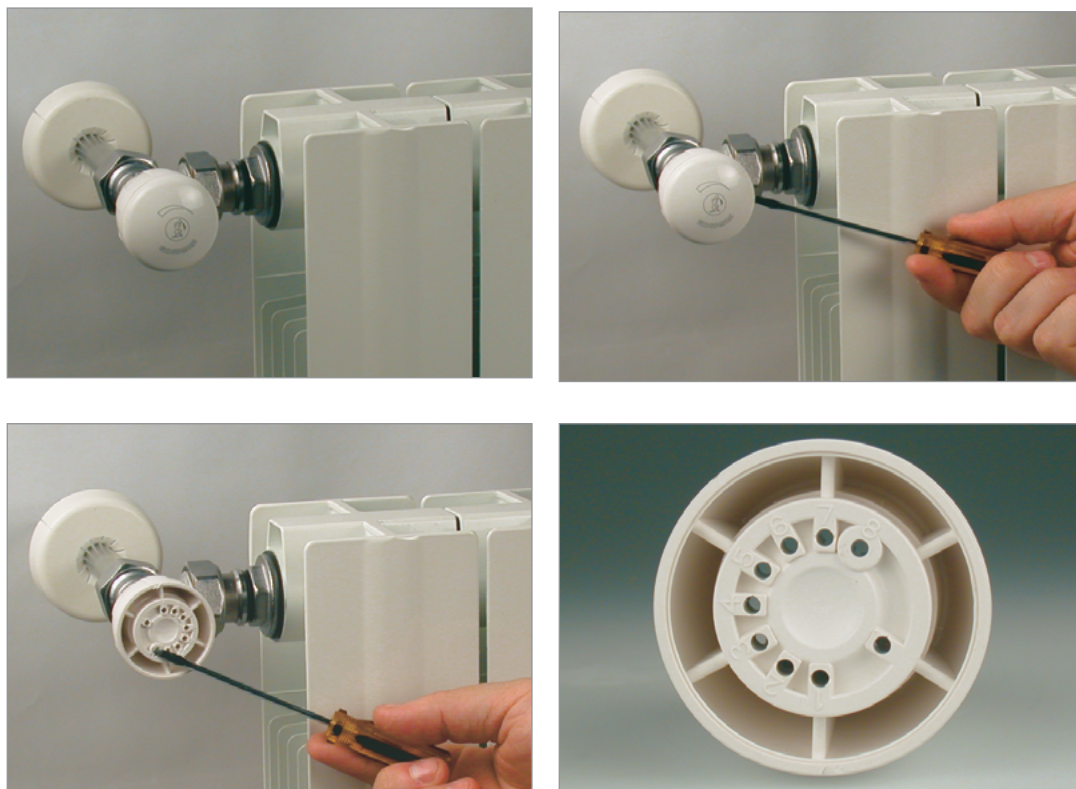

The adjustment can be made shifting the metal pin in the position that best suits one's needs, according to the specific diagrams reported in the Hydraulic Versions and Characteristics.

### Technical Data

- Fluids: hot water
- Temperature range: 5 ÷ 110 °C
- Max operating pressure for manual applications: 16 bar
- Max operating pressure in association with thermostatic heads: 10 bar
- Max differential pressure:
  - 0,14 MPa (1,4 bar), 3/8" - 1/2" - 3/4" (except for F series)
  - 0,07 MPa (0,7 bar), 3/4" (only F series)
  - 0,04 MPa (0,4 bar), 1"

### Materials

- Bodies, caps and pipe unions: brass UNI EN 12165 CW617N
- Operation handwheels: ABS
- Self-sealing: EPDM

## Hydraulic versions and characteristics

In the following tables the values of Kv are reported according to the micrometric adjustment set positioning the metal pin (as described in the previous paragraph).  $\Delta T=2K$  refers to the situation of valve with thermostatic head installed.

**R431TG**



**Micrometric angle valve with thermostatic option, chrome plated, adaptor connection and self-sealing tail piece.**

PRODUCT CODE	SIZE	POSITION					$\Delta T=2K$
		2	3	4	6	8	
R431X032	3/8"x16	0,40	0,62	0,80	1,02	1,26	0,51
R431X033	1/2"x16	0,40	0,62	0,80	1,02	1,26	0,51
R431X034	1/2"x18	0,40	0,62	0,80	1,02	1,26	0,51
R431EX037	1/2"x3/4"E	0,40	0,62	0,80	1,02	1,26	0,51

**NOTE**  
R178, R179 or R179AM adaptor connections to be used.  
Use R178E, R179E adaptors for R431EX037

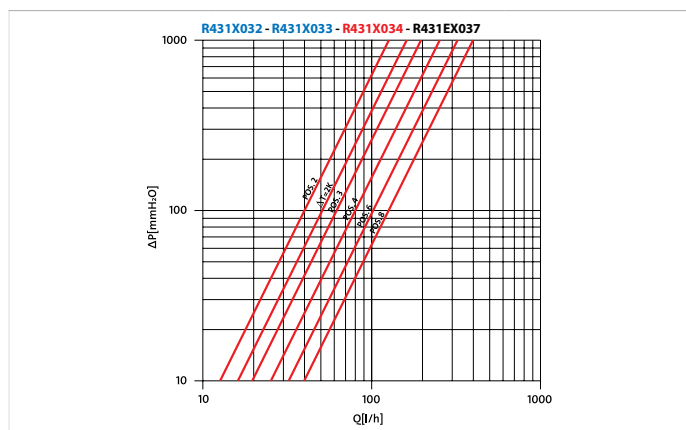

**R421TG**



**Micrometric angle valve with thermostatic option, chrome plated, iron pipe connection and self-sealing tail piece.**

PRODUCT CODE	SIZE	POSITION					$\Delta T=2K$
		2	3	4	6	8	
R421X132	3/8"x3/8"	0,40	0,58	0,78	1,00	1,26	0,51
R421X133	1/2"x1/2"	0,42	0,62	0,80	1,02	1,26	0,51
R421FX004	3/4"x3/4"*	-	-	-	-	2,37	0,80
R421X034	3/4"x3/4"*	0,50	0,80	0,90	1,25	1,41	0,76
R421X035	1"x1"*	1,37	1,85	2,38	3,36	3,98	1,22

**NOTE**  
\* Tail pieces without self sealing  
CERTIFICATION AND SYMBOLS R421X132-R421X133-R421FX004

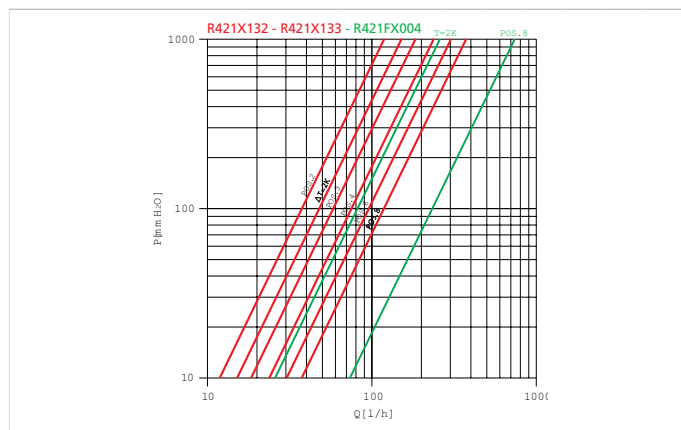
**R432TG**



**Micrometric straight valve with thermostatic option, chrome plated, adaptor connection and self-sealing tail piece.**

PRODUCT CODE	SIZE	POSITION					$\Delta T=2K$
		2	3	4	6	8	
R432X032	3/8"x16	0,40	0,62	0,80	1,02	1,26	0,51
R432X033	1/2"x16	0,40	0,62	0,80	1,02	1,26	0,51
R432X034	1/2"x18	0,40	0,62	0,80	1,02	1,26	0,51

**NOTE**  
R178, R179 or R179AM adaptor connections to be used.

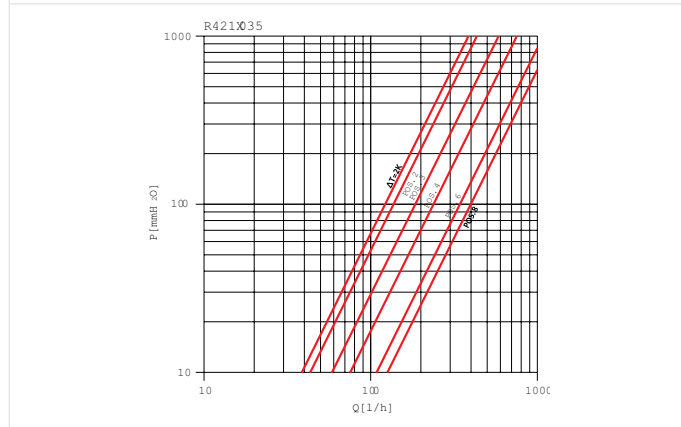
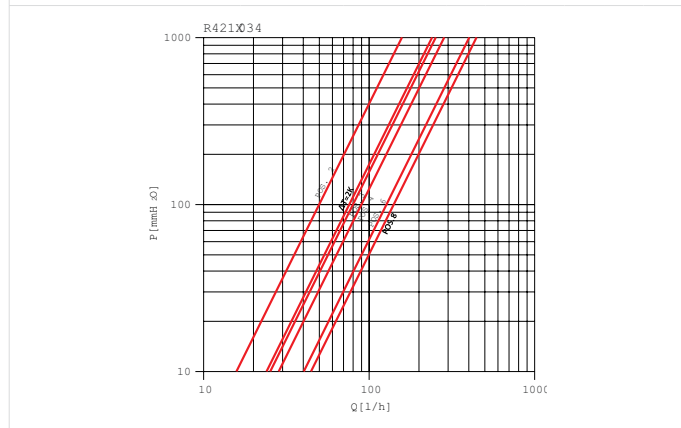
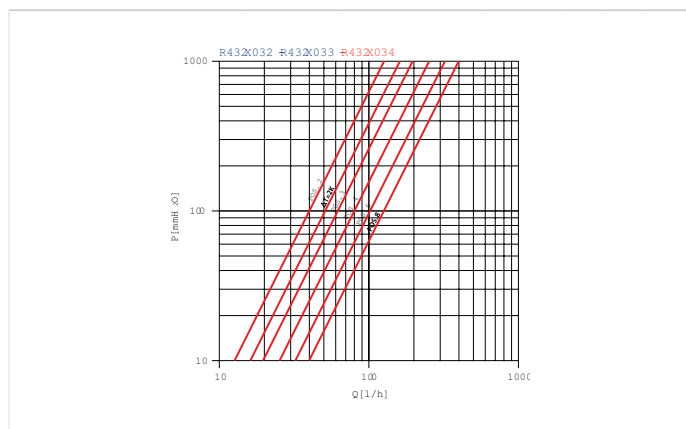

**R422TG**



Micrometric straight valve with thermostatic option chrome plated, iron pipe connection and self-sealing tail piece.

PRODUCT CODE	SIZE	POSITION					ΔT=2K
		2	3	4	6	8	
R422X132	3/8"x3/8"	0,40	0,58	0,78	1,00	1,26	0,51
R422X133	1/2"x1/2"	0,42	0,62	0,80	1,02	1,26	0,51
R422FX004	3/4"x3/4"	-	-	-	-	2,37	0,80
R422X034	3/4"x3/4"	0,50	0,80	0,90	1,25	1,41	0,76
R422X035	1"x1"	1,37	1,73	2,10	2,82	2,95	1,15

**NOTE**

\* Tail pieces without self sealing

CERTIFICATION AND SYMBOLS R422X132-R422X133-R422FX004



**R435TG**



Micrometric angle valve with thermostatic option, chrome plated and self-sealing tail pieces. Available with iron pipe connection and with adaptor connection.

PRODUCT CODE	SIZE	POSITION					ΔT=2K
		2	3	4	6	8	
R435X053	1/2"x1/2" *	0,40	0,62	0,80	1,02	1,26	0,51
R435X062	1/2"x16	0,40	0,62	0,80	1,02	1,26	0,51
R435X043	1/2"x18	0,40	0,62	0,80	1,02	1,26	0,51

**NOTE**

R435X042, R435X043: R178, R179 or R179AM adaptor connections to be used.

\* Iron pipe connection

CERTIFICATION AND SYMBOLS R435X033

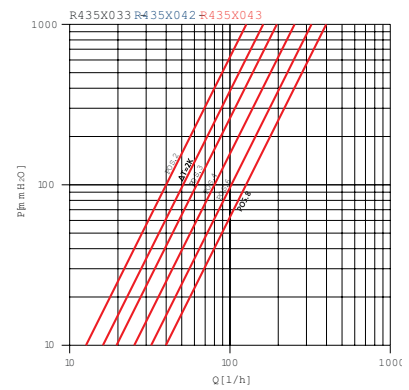
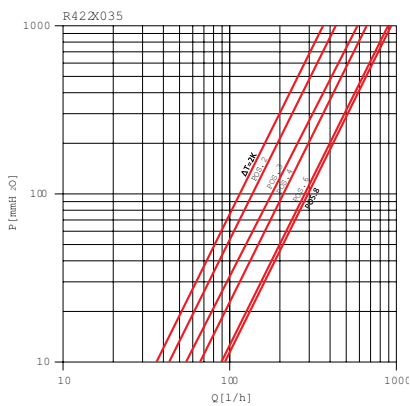
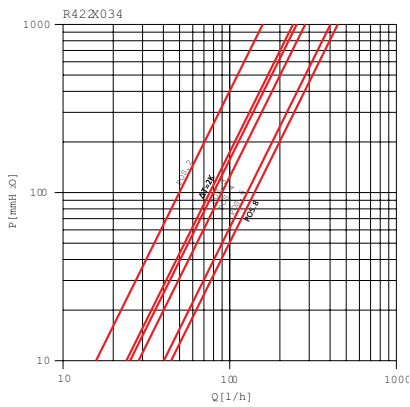
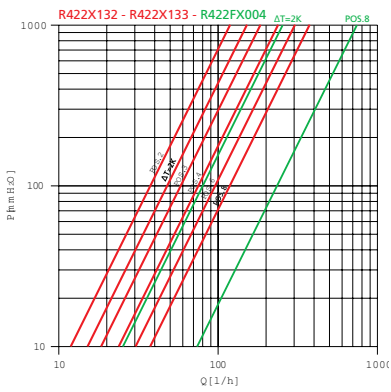

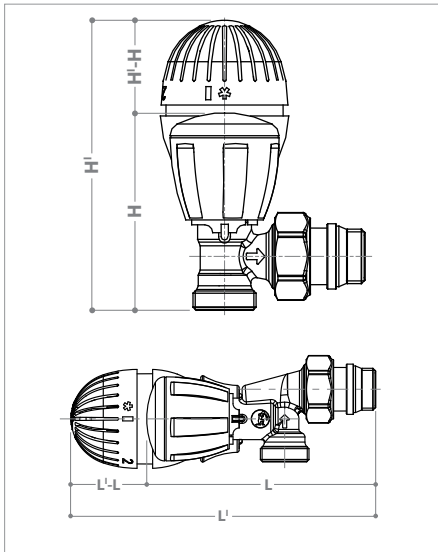

**Caution.**  
On systems equipped with thermostatic heads, the use of the R147N pressure differential valves is recommended, in order to avoid over pressure phenomenon at the closing of the mentioned actuators.

VERSION	R460X001	R470X001	R468CX001	R468X001
H'-H	53 mm	35 mm	63 mm	52
L'-L FOR R435	53 mm	35 mm	63 mm	52



### Volumes and dimensions [mm]

#### R431TG

PRODUCT CODE	GxB	H	I	J	L	M	W
R431X032	3/8"x16	75	53	21	74	42	30
R431X033	1/2"x16	75	53	21	74	42	30
R431X034	1/2"x18	75	53	21	74	42	30
R431EX037	1/2"x3/4"E	75	53	21	74	42	30

#### R432TG

PRODUCT CODE	GxB	H	I	J	L	M	W
R432X032	3/8"x16	79	51	17	74	42	30
R432X033	1/2"x16	79	51	17	75	42	30
R432X034	1/2"x18	79	51	17	76	42	30

#### R421TG

PRODUCT CODE	GxB	H	I	J	K	L	M	W
R421X132	3/8"x3/8"	74	51	20	22	72	42	27
R421X133	1/2"x1/2"	78	53	23	26	74	42	30
R421FX004	3/4"x3/4"	87	58	26	32	76	42	38
R421X034	3/4"x3/4"	79	60	25	32	81	42	38
R421X035	1"x1"	97	72	31	39	94	42	46

#### R422TG

PRODUCT CODE	GxB	H	I	J	K	L	M	W
R422X132	3/8"x3/8"	77	54	15	22	76	42	27
R422X133	1/2"x1/2"	79	55	17	26	82	42	30
R422FX004	3/4"x3/4"	89	61	22	32	93	42	38
R422X034	3/4"x3/4"	83	55	21	32	81	42	38
R422X035	1"x1"	95	64	26	39	105	42	46

#### R435TG

PRODUCT CODE	GxB	H	I	J	K	L	M	W
R435X053	1/2"x1/2"*	53	53	36	25	121	42	30
R435X062	1/2"x16	53	45	36	-	113	42	30
R435X043	1/2"x18	53	45	37	-	113	42	30

NOTE: R435X033 hexagonal connection for iron pipe

## Additional information for KEYMARK - EN215 certified valves

Product Code	Size	Thermostatic Head	Nominal supply qmNH in association with the heads	Authority of the shutter	Z (min)	W(K)
R421X132 R422X132	3/8"	R460	150 Kg/h	0,892	26	0,90
R421X133 R422X133	1/2"	R460	150 Kg/h	0,924		
R435X033	1/2"	R460	150 Kg/h	0,832		
R421FX004	3/4"	R460	240 Kg/h	0,873		
R422FX004	3/4"	R460	240 Kg/h	0,897		
R421X132 R422X132	3/8"	R468C	150 Kg/h	0,892	25	0,26
R421X133 R422X133	1/2"	R468C	150 Kg/h	0,924		
R435X033	1/2"	R468C	150 Kg/h	0,832		
R421FX004	3/4"	R468C	240 Kg/h	0,873		
R422FX004	3/4"	R468C	240 Kg/h	0,897		
R421X132 R422X132	3/8"	R468	150 Kg/h	0,892	25	0,42
R421X133 R422X133	1/2"	R468	150 Kg/h	0,924		
R435X033	1/2"	R468	150 Kg/h	0,832		
R421FX004	3/4"	R468	240 Kg/h	0,873		
R422FX004	3/4"	R468	240 Kg/h	0,897		
R421X132 R422X132	3/8"	R470	150 Kg/h	0,892	26	1,2
R421X133 R422X133	1/2"	R470	150 Kg/h	0,926		
R435X033	1/2"	R470	150 Kg/h	0,849		
R421FX004	3/4"	R470	240 Kg/h	0,873		
R422FX004	3/4"	R470	240 Kg/h	0,897		

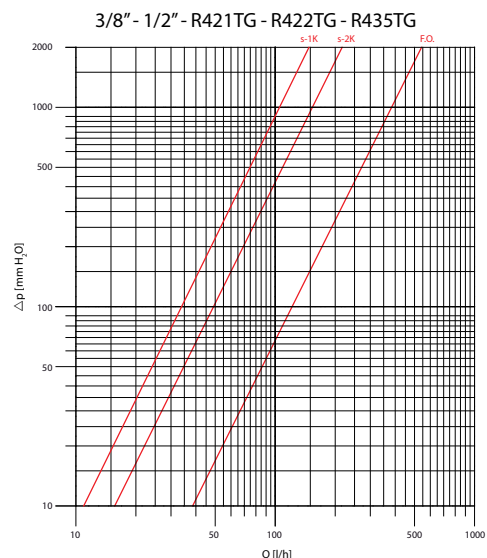

3/8" - 1/2"	Kv
s - 1K	0,33
s - 2K	0,51
Fully Open	1,26

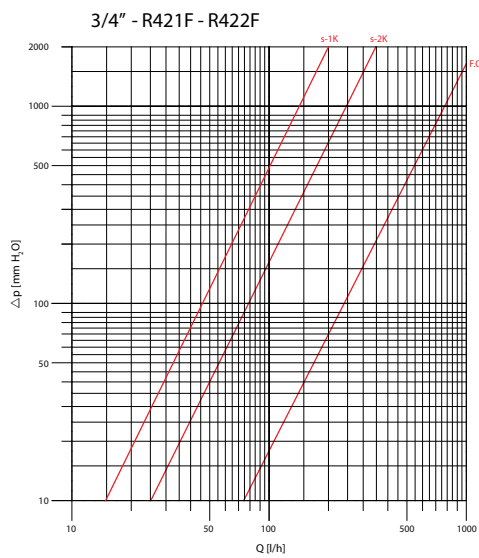

3/4"	Kv
s - 1K	0,44
s - 2K	0,80
Fully Open	2,37

C - declared hysteresis: 0,35K (R460); 0,23 K (R468C, R468); 0,4K (R470)

D - declared influence of differential pressure: 0,4K (R460); 0,15K (R468C, R468); 0,55K (R470)

W - declared influence of water temperature: see table

Z - declared response times: see table

Min calibration in association with thermostatic heads R460, R468C, R468, R470: 8 °C in position\*

Max operating pressure in association with thermostatic heads: 10 bar

All declared values comply with the requirements of the UNI EN215 standard - July 2007.



## THERMOSTATIC VALVES

### Protection handle

The series of Giacotech thermostatic valves with protection handle is especially recommended for the assemblies with thermostatic heads or electrothermal actuators installation for the control of ambient temperature, aimed at maintaining the comfort conditions in addition to optimising consumptions. The building yard protection anyway allows separating the supply of the valve. Turning the red cap counter clockwise to open it and the opposite to close it. Red cap's rotations of 36° correspond to temperature variations equal to 1 °C. The protection with the red cap tightly closed in addition allows largely exceeding differential pressures of 10 bar with the system off. Anyway we recommend carrying out pressure tightness tests only after connecting the heating bodies in order to avoid, in case of damage to the mechanism, causing floods.

### Technical data

- Fluids: hot water
- Temperature range: 5÷110 °C
- Max operating pressure for manual applications: 16 bar
- Max operating pressure in association with thermostatic heads: 10 bar
- Max. differential pressure:
  - 0,14 MPa (1,4 bar), 3/8" - 1/2" - 3/4" (except for F series)
  - 0,07 MPa (0,7 bar), 3/4" (only F series)
  - 0,04 MPa (0,4 bar), 1"

### Materials

- Bodies, caps and pipe unions: brass UNI EN 12165 CW617N
- Operation handwheels: PP-H
- Self-sealing: EPDM

### Hydraulic versions and characteristics

The following tables report the values of Kv with thermostatic head installed. Usually at the stage of design reference is made to the situation ΔT=2K. T.A.= all open

**R411TG**



**Angle valve with thermostatic option, chrome plated, with adaptor connection, self-sealing and cover to protect body before assembling.**

PRODUCT CODE	SIZE	ΔT=1K	ΔT=2K	T.A.
R411X032	3/8"x16	0,33	0,51	1,26
R411X033	1/2"x16	0,33	0,51	1,26
R411X034	1/2"x18	0,33	0,51	1,26

**NOTE**

R178, R179 or R179AM adaptor connections to be used.

**R412TG**



**Straight valve with thermostatic option, chrome plated, with adaptor connection, self-sealing and cover to protect body before assembling.**

PRODUCT CODE	SIZE	ΔT=1K	ΔT=2K	T.A.
R412X032	3/8"x16	0,33	0,51	1,26
R412X033	1/2"x16	0,33	0,51	1,26
R412X034	1/2"x18	0,33	0,51	1,26

**NOTE**

R178, R179 or R179AM adaptor connections to be used.

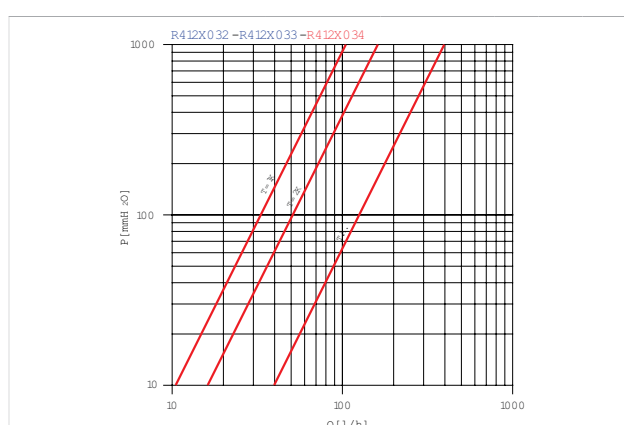
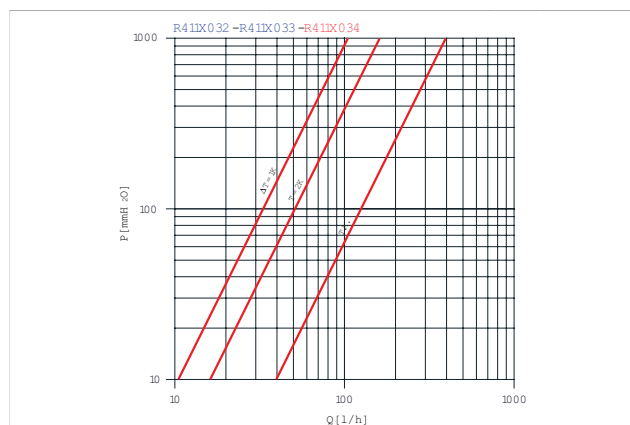

**R401TG**



Angle valve with thermostatic option, chrome plated, with iron pipe connection and cover to protect body before assembling.

PRODUCT CODE	SIZE	$\Delta T=1K$	$\Delta T=2K$	T.A.
R401X132	3/8"x3/8"	0,33	0,51	1,26
R401X133	1/2"x1/2"	0,33	0,51	1,26
R401FX004	3/4"x3/4"*	0,44	0,80	2,37
R401X034	3/4"x3/4"*	0,50	0,76	1,41
R401X035	1"x1"*	-	1,22	3,98

**NOTE**

\* Tail pieces without self sealing

CERTIFICATION AND SYMBOLS R401X132-R401X133-R401FX004

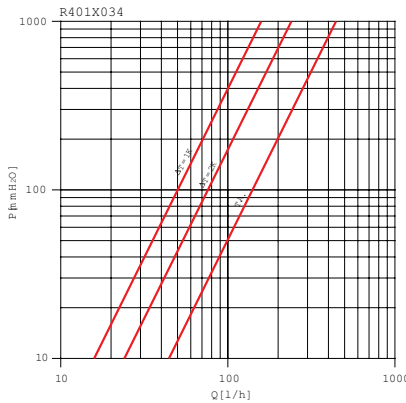
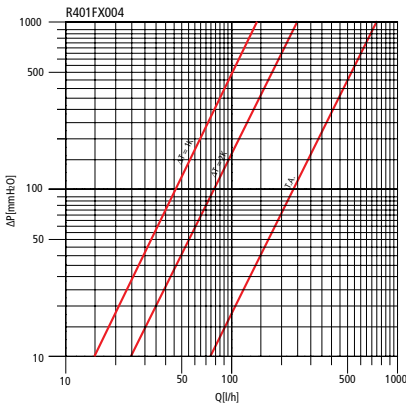
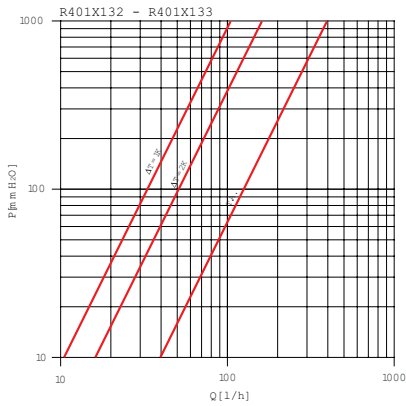
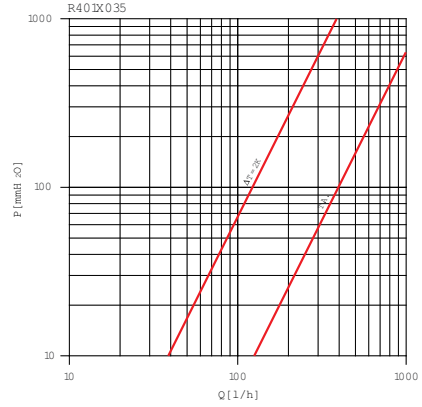

**R402 TG**



Straight valve with thermostatic option, chrome plated, with iron pipe connection and cover to protect body before assembling.

PRODUCT CODE	SIZE	$\Delta T=1K$	$\Delta T=2K$	T.A.
R402X132	3/8"x3/8"	0,33	0,51	1,26
R402X133	1/2"x1/2"	0,33	0,51	1,26
R402FX004	3/4"x3/4"*	0,44	0,80	2,37
R402X034	3/4"x3/4"*	0,50	0,76	1,41
R402X035	1"x1"*	-	1,15	2,95

**NOTE**

\* Tail pieces without self sealing

CERTIFICATION AND SYMBOLS R402X132-R402X133-R402FX004

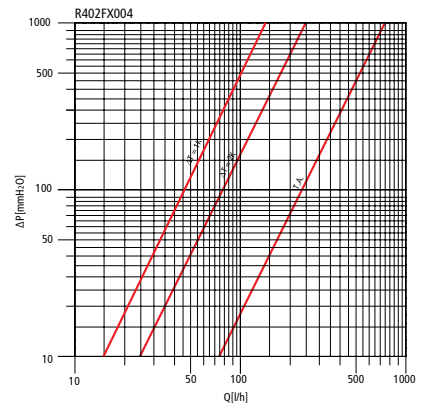
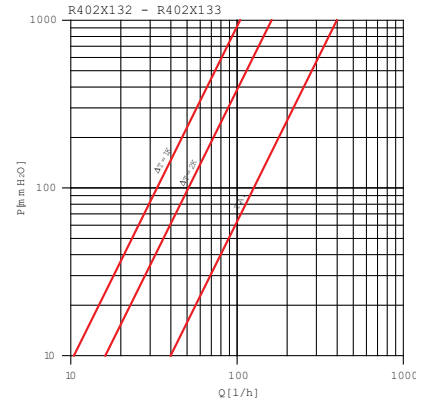

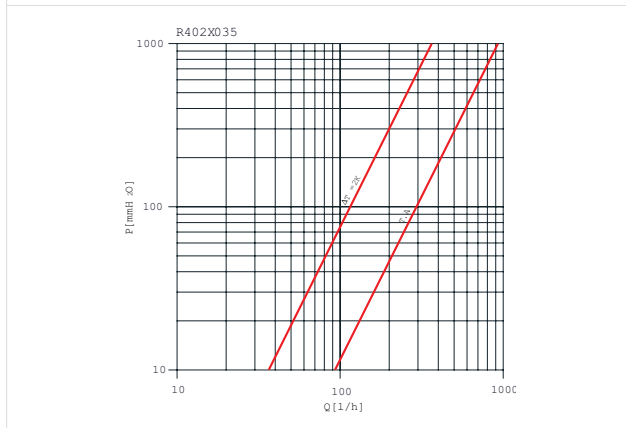
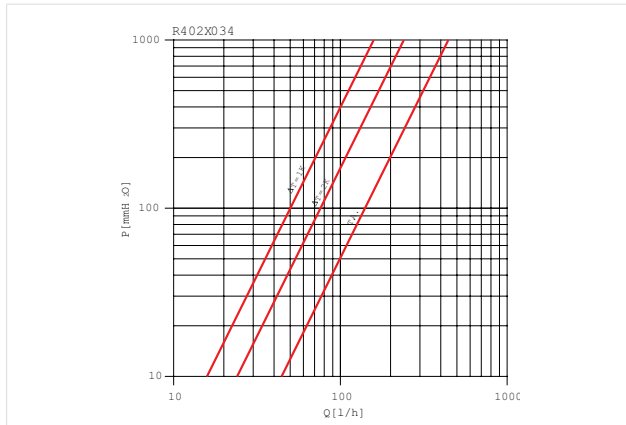

### R415TG



Angle valve with thermostatic option, chrome plated self-sealing tail piece, with cover to protect body before assembling. Available with iron pipe connection and with adaptor connection.

PRODUCT CODE	SIZE	ΔT=1K	ΔT=2K	T.A.
R415X033	1/2"x1/2"*	0,33	0,51	1,26
R415X042	1/2"x16	0,33	0,51	1,26
R415X043	1/2"x18	0,33	0,51	1,26

**NOTE**  
R178, R179 or R179AM adaptor connections to be used.

\* Iron pipe connection

CERTIFICATION AND SYMBOLS R415X033

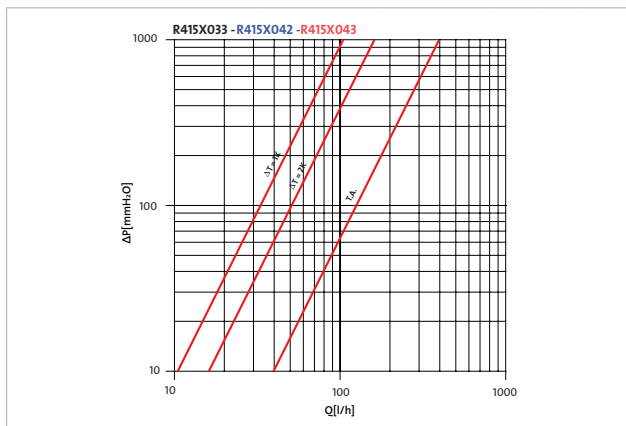
### R403TG



Double angle valve with thermostatic option, chrome plated self-sealing tail piece, with cover to protect body before assembling. Available with iron pipe connection and with adaptor connection.

PRODUCT CODE	SIZE	ΔT=1K	ΔT=2K	T.A.
R403X052	3/8"x3/8"lf*	0,33	0,51	1,26
R403X062	3/8"x3/8"rg*	0,33	0,51	1,26
R403X054	1/2"x1/2"lf*	0,33	0,51	1,26
R403X064	1/2"x1/2"rg*	0,33	0,51	1,26
R403X024	1/2"x18 lf	0,33	0,51	1,26
R403X034	1/2"x18 rg	0,33	0,51	1,26

**NOTE**  
For adaptor version: R178, R179 or R179AM adaptor connections to be used.

\* Iron pipe connection.

"lf": frontal head connection and supply from the bottom, valve on the left of the radiator.

"rg": frontal head connection and supply from the bottom, valve on the right of the radiator.

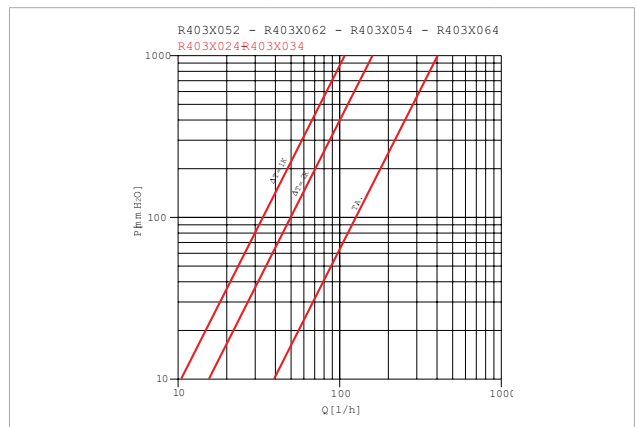

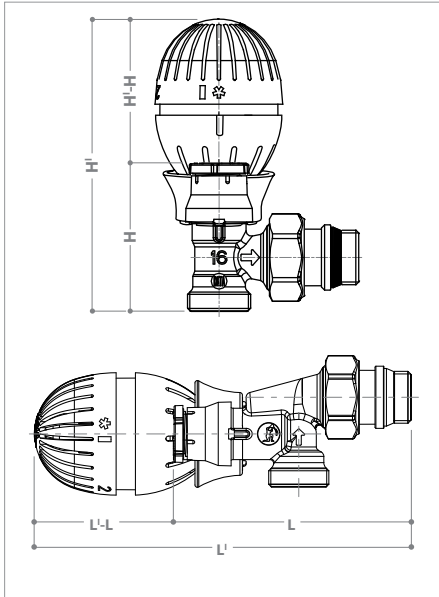

**Caution.**

On systems equipped with thermostatic heads, the use of the R147N pressure differential valves is recommended, in order to avoid over pressure phenomenon at the closing of the mentioned actuators.

VERSION	R460X001	R470X001	R468CX001	R468X001
H-H	71 mm	54 mm	81 mm	71
L-L for R415	71 mm	54 mm	81 mm	71



**Volumes and dimensions [mm]**

**R411TG**

PRODUCT CODE	GxB	H	I	J	L	M	W
R411X032	3/8"x16	56	53	21	66	23	30
R411X033	1/2"x16	56	53	21	66	23	30
R411X034	1/2"x18	56	53	21	66	23	30

**R412TG**

PRODUCT CODE	GxB	H	I	J	L	M	W
R412X032	3/8"x16	60	51	17	74	23	30
R412X033	1/2"x16	60	51	17	75	23	30
R412X034	1/2"x18	60	51	17	76	23	30

**R401TG**

PRODUCT CODE	GxB	H	I	J	K	L	M	W
R401X132	3/8"x3/8"	55	51	20	22	64	23	27
R401X133	1/2"x1/2"	59	53	23	26	68	23	30
R401FX004	3/4"x3/4"	68	62	26	32	765	23	38
R401X034	3/4"x3/4"	60	60	25	32	78	23	38
R401X035	1"x1"	78	72	31	39	94	23	46

**R402TG**

PRODUCT CODE	GxB	H	I	J	K	L	M	W
R402X132	3/8"x3/8"	58	54	15	22	76	23	27
R402X133	1/2"x1/2"	60	55	17	26	82	23	30
R402FX004	3/4"x3/4"	70	61	22	32	97	23	38
R402X034	3/4"x3/4"	64	55	21	32	81	23	38
R402X035	1"x1"	76	64	26	39	105	23	46

**R403TG**

PROD. CODE	GxB	H	I	I'	J	L	L'	M	W	W'
R403X052	3/8"x3/8" sx	43	50	57	27	65	71	23	30	27
R403X062	3/8"x3/8" dx	43	50	57	27	65	71	23	30	27
R403X054	1/2"x1/2" sx	43	50	57	27	65	71	23	30	27
R403X064	1/2"x1/2" dx	43	50	57	27	65	71	23	30	27
R403X024	1/2"x18 sx	41	50	58	24	63	71	23	30	-
R403X034	1/2"x18 dx	41	50	58	24	63	71	23	30	-

NOTE: R403X052, R403X062 R403X054, R403X064 hexagonal connection for iron pipe

PRODUCT CODE	GxB	H	I	J	K	L	M	W
R415X033	1/2"x1/2"	53	53	36	25	106	23	30
R415X042	1/2"x16	53	45	36	-	94	23	30
R415X043	1/2"x18	53	45	37	-	94	23	30

NOTE: R415X033 hexagonal connection for iron pipe

**R415TG**

## Additional information for KEYMARK - EN215 certified valves

Product Code	Size	Thermostatic Head	Nominal supply qmNH in association with the heads	Authority of the shutter	Z (min)	W(K)
R401X132 R402X132	3/8"	R460	150 Kg/h	0,892	26	0,9
R401X133 R402X133	1/2"	R460	150 Kg/h	0,924		
R415X033	1/2"	R460	150 Kg/h	0,832		
R401FX004	3/4"	R460	240 Kg/h	0,873		
R402FX004	3/4"	R460	240 Kg/h	0,897		
R401X132 R402X132	3/8"	R468C	150 Kg/h	0,892	25	0,26
R401X133 R402X133	1/2"	R468C	150 Kg/h	0,924		
R415X033	1/2"	R468C	150 Kg/h	0,832		
R401FX004	3/4"	R468C	240 Kg/h	0,873		
R402FX004	3/4"	R468C	240 Kg/h	0,897		
R401X132 R402X132	3/8"	R468	150 Kg/h	0,892	25	0,42
R401X133 R402X133	1/2"	R468	150 Kg/h	0,924		
R415X033	1/2"	R468	150 Kg/h	0,832		
R401FX004	3/4"	R468	240 Kg/h	0,873		
R402FX004	3/4"	R468	240 Kg/h	0,897		
R401X132 R402X132	3/8"	R470	150 Kg/h	0,892	26	1,2
R401X133 R402X133	1/2"	R470	150 Kg/h	0,926		
R415X033	1/2"	R470	150 Kg/h	0,849		
R401FX004	3/4"	R470	240 Kg/h	0,873		
R402FX004	3/4"	R470	240 Kg/h	0,897		

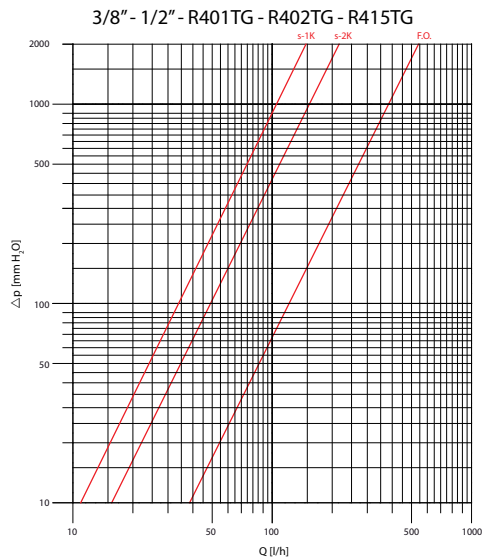

3/8" - 1/2"	Kv
s - 1K	0,33
s - 2K	0,51
Fully Open	1,26

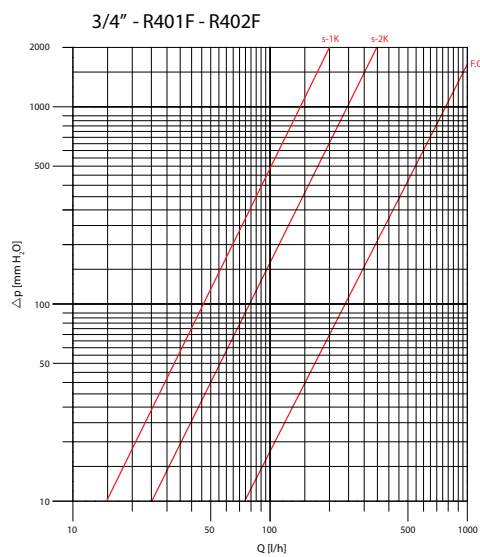

3/4"	Kv
s - 1K	0,44
s - 2K	0,80
Fully Open	2,37

C - declared hysteresis: 0,35K (R460); 0,23 K (R468C, R468); 0,4K (R470)

D - declared influence of differential pressure: 0,4K (R460); 0,15K (R468C, R468); 0,55K (R470)

W - declared influence of water temperature: see table

Z - declared response times: see table

Min calibration in association with thermostatic heads R460, R468C, R468, R470: 8 °C in position\*

Max operating pressure in association with thermostatic heads: 10 bar

All declared values comply with the requirements of the UNI EN215 standard - July 2007.

## Thermostatic element

The series of Giacotech thermostatic valves and micrometric thermostatic valves can be easily equipped with thermostatic heads of thermoelectric actuators in order to allow, quite simply, the automation of ambient temperature control thus guaranteeing comfort and significant energy saving. So thermostatic heads with liquid sensor (R460, R470), with remote sensor (R462), with remote adjustment sensor (R463), can be used or thermoelectric actuators normally open (R478/R478M) or normally closed (R473/R473M) directly controlled by ordinary ambient thermostats.



## Anti-blocking-system screw-down valve

The series of Giacotech micrometric and thermostatic micrometric valves features a system called anti-blocking-system. Inside the operation mechanism there is an operation rod in stainless steel in a single piece, obtained with cold moulding and successive roll-forming, strongly reduces the adhesion capability of lime deposits and consequently the possibility of screw down blocking.

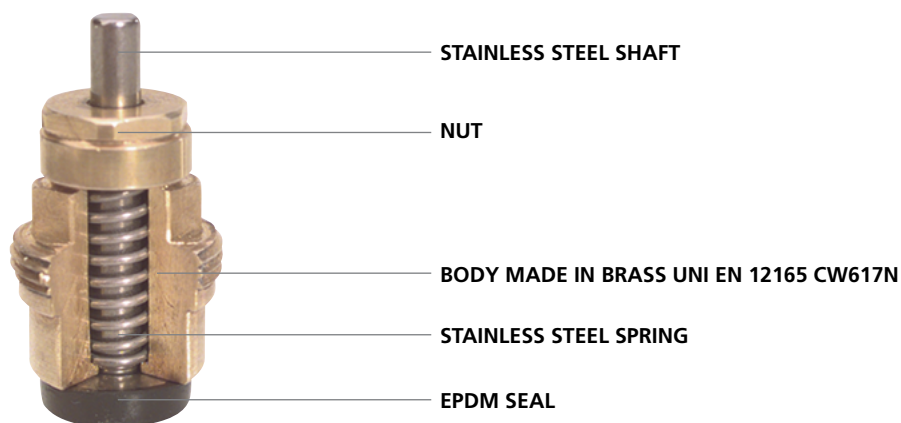

## MANUAL VALVES

The widespread habit of installing manual valves led Giacomini to introduce within the Giacotech series also this kind of valves. The Giacotech manual valves are easy to operate, and in addition the new handle is more comfortable and is equipped with a specific building yard protection.

### Technical data

- Fluids: hot water
- Temperature range: 5÷110 °C
- Max operating pressure for manual applications: 16 bar

### Materials

- Bodies, caps, pipe unions: UNI EN 12165 CW617N brass
- Operation hand wheels: ABS
- Self-sealing: EPDM

### Hydraulic versions and characteristics

The following tables show the Kv values referred to situations of all open valve.



R25TG

**Manual angle valve, chrome plated, with iron screwed end and self-sealing tail piece.**

PRODUCT CODE	SIZE	Kv
R25X032	3/8"x16	2,88
R25X033	1/2"x16	2,88
R25X034	1/2"x18	2,88
R25X035	3/4"x18*	5,34
R25X034	3/4"x22*	5,34

NOTE

R178, R179 or R179AM adaptor connections to be used.

\* tail pieces without self sealing



R27TG

**Manual straight valve, chrome plated, with iron screwed end and self-sealing tail piece.**

PRODUCT CODE	SIZE	Kv
R27X032	3/8"x16	2,50
R27X033	1/2"x16	2,50
R27X034	1/2"x18	2,50
R27X035	3/4"x18*	3,65
R27X034	3/4"x22*	3,65

NOTE

R178, R179 or R179AM adaptor connections to be used.

\* tail pieces without self sealing

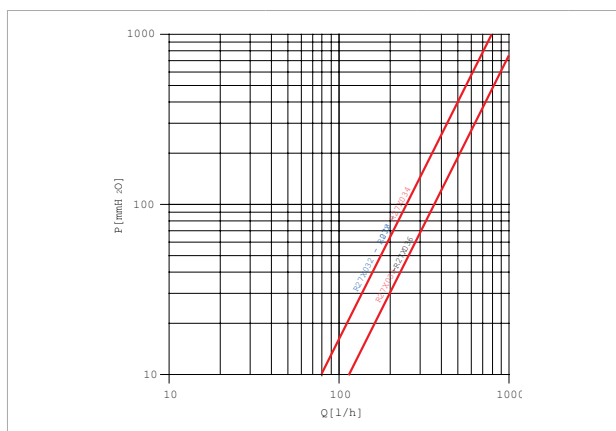
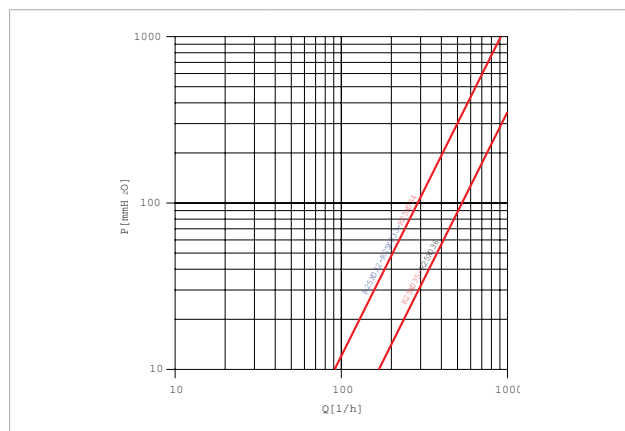

**R5TG**



Manual angle valve, chrome plated, with iron pipe connection and self-sealing tail piece.

PRODUCT CODE	SIZE	Kv
R5X032	3/8"x3/8"	2,46
R5X033	1/2"x1/2"	2,88
R5X034	3/4"x3/4"*	5,34
R5X035	1"x1"*	11,50
R5X036	1 1/4"x1 1/4"*	-

**NOTE**  
\* Tail pieces without self sealing

**R6TG**



Manual straight valve, screwed ends, chrome plated and self-sealing tail pieces.

PRODUCT CODE	SIZE	Kv
R6X032	3/8"x3/8"	1,58
R6X033	1/2"x1/2"	2,50
R6X034	3/4"x3/4"*	3,65
R6X035	1x1*	8,45
R6X036	1 1/4"x1 1/4"*	-

**NOTE**  
\* Tail pieces without self sealing

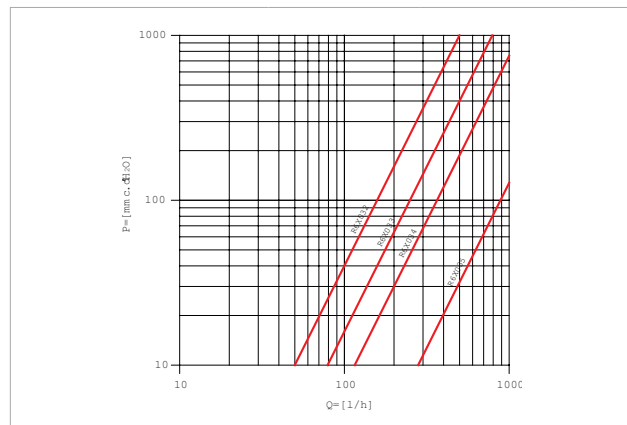
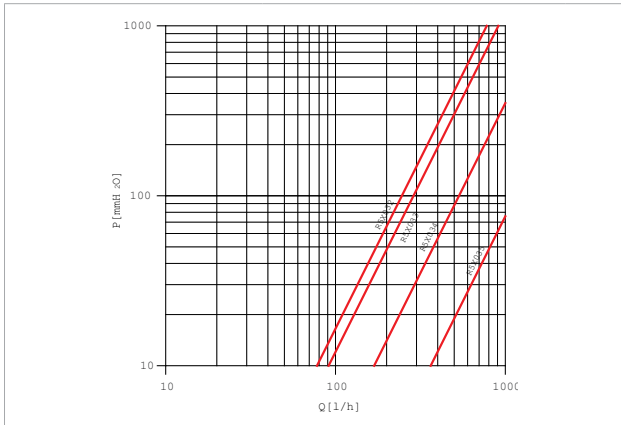

**Volumes and dimensions [mm]**

**R25TG**

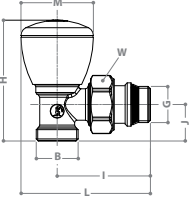

PRODUCT CODE	GxB	H	I	J	L	M	W
R25X032	3/8"x16	69	53	21	74	42	30
R25X033	1/2"x16	69	53	21	74	42	30
R25X034	1/2"x18	73	54	24	75	42	30
R25X033	3/4"x18	79	60	24	84	49	38
R25X036	3/4"x22	79	60	24	84	49	38

**R27TG**

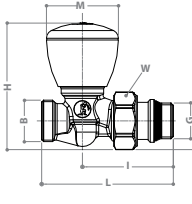

PRODUCT CODE	GxB	H	I	J	L	M	W
R27X032	3/8"x16	73	52	17	75	42	30
R27X033	1/2"x16	73	52	17	76	42	30
R27X034	1/2"x18	73	52	17	77	42	30
R27X033	3/4"x18	87	55	21	81	49	38
R27X036	3/4"x22	87	55	21	91	49	38

**R5TG**

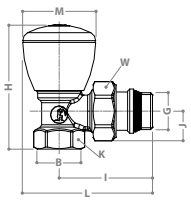

PRODUCT CODE	GxB	H	I	J	K	L	M	W
R5X032	3/8"x3/8"	65	50	19	22	71	42	27
R5X033	1/2"x1/2"	70	53	21	26	74	42	30
R5X034	3/4"x3/4"	79	60	23	32	84	49	38
R5X035	1"x1"	87	68	30	39	92	49	46
R5X036	1 1/4"x1 1/4"	92	81	33	49	110	59	53

**R6TG**

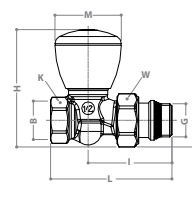

PRODUCT CODE	GxB	H	I	J	K	L	M	W
R6X032	3/8"x3/8"	69	56	15	22	77	42	27
R6X033	1/2"x1/2"	73	60	17	26	76	42	30
R6X034	3/4"x3/4"	86	55	21	32	81	49	38
R6X035	1"x1"	93	69	26	39	106	49	46
R6X036	1 1/4"x1 1/4"	97	84	30	49	135	59	53



## LOCKSHIELDS

System adjustment.

In order to make available for the operator a complete installation system, the Giacotech series also includes lockshields, essential elements for proper system balancing.



This operation, to make according to design characteristics of the system and of hydraulic characteristics of the product at issue, is crucial to guarantee the proper operation of the system. Removing the upper cap you can reach easily the adjustment rod that should be operated with the help of a specific hexagonal wrench (R73). Starting from the position of all closed the shutter is opened according to what the system design provides for.

## Technical data

- Fluids: hot water
- Temperature range: 5÷110 °C
- Max operating pressure for manual applications: 16 bar

## Materials

- Bodies, caps and pipe unions: UNI EN 12165 CW617N brass
- Self-sealing: EPDM

## Versions and hydraulic characteristics

The following tables show the values of Kv according to the n° of opening turns of the lockshield starting from the position of complete closing.

T.A.= (tutto aperto) all open

**R29TG**



**Angle lockshield valve, chrome plated, with adaptor connection and self-sealing tail piece.**

PRODUCT CODE	SIZE	NUMBER OF OPENING TURNS					T.A.
		0,5	1	2	4	6	
R29X032	3/8"x16	0,34	0,73	1,60	2,52	-	3,16
R29X033	1/2"x16	0,34	0,73	1,60	2,52	-	3,16
R29X034	1/2"x18	0,34	0,73	1,60	2,52	-	3,16
R29X035	3/4"x18*	0,35	0,89	1,60	2,52	3,46	6,32
R29X036	3/4"x22*	0,35	0,89	1,60	2,52	2,95	6,32

NOTE

R178, R179 or R179AM adaptor connections to be used.

\*Tail pieces without self sealing - Brass caps.

**R31TG**



**Straight lockshield valve, chrome plated, with adaptor connection and self-sealing tail piece.**

PRODUCT CODE	SIZE	NUMBER OF OPENING TURNS					T.A.
		0,5	1	2	4	6	
R31X032	3/8"x16	0,27	0,59	1,20	-	-	1,83
R31X033	1/2"x16	0,27	0,59	1,20	-	-	1,83
R31X034	1/2"x18	0,27	0,59	1,20	-	-	1,83
R31X035	3/4"x18*	0,35	0,94	1,76	2,50	4,71	4,71
R31X036	3/4"x22*	0,35	0,94	1,76	2,50	4,71	4,71

NOTE

R178, R179 or R179AM adaptor connections to be used.

\*Tail pieces without self sealing - Brass caps.

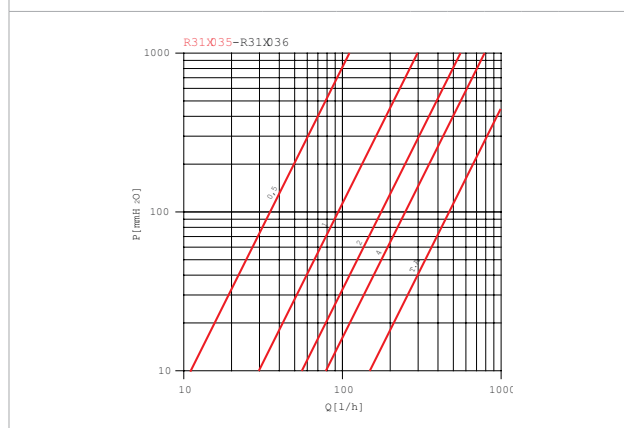
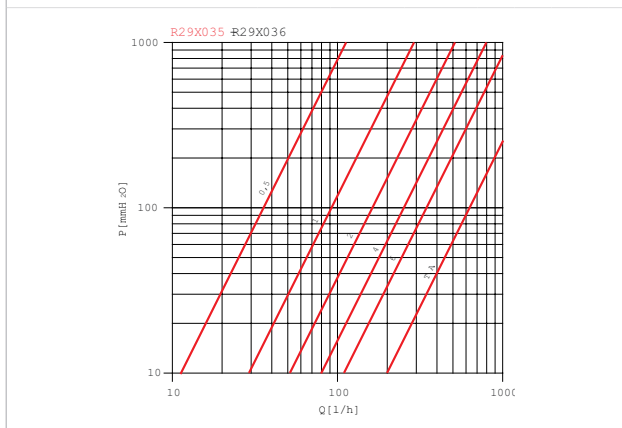
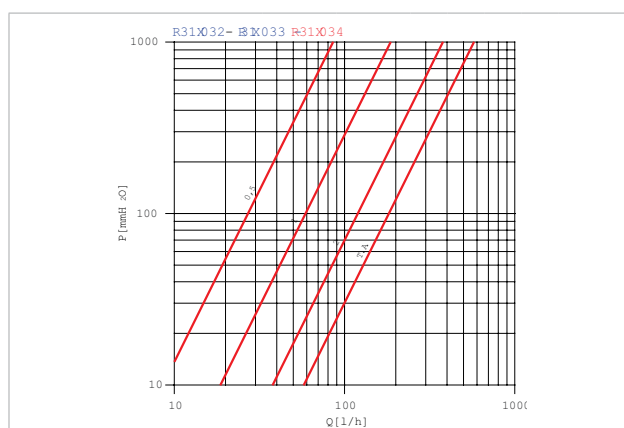
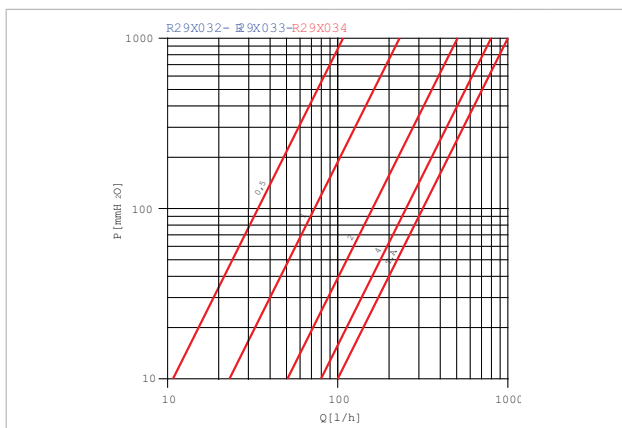

**R14TG**

Angle lockshield valve, chrome plated, with iron pipe connection.



PRODUCT CODE	SIZE	NUMBER OF OPENING TURNS				T.A.
		0,5	1	2	4	
R14X032	3/8"x3/8"	0,24	0,51	1,13	-	2,21
R14X033	1/2"x1/2"	0,34	0,73	1,60	-	3,16
R14X034	3/4"x3/4"*	0,35	0,89	1,60	3,46	6,32
R14X035	1"x1"*	0,51	1,15	2,12	4,00	11,80
R14X036	1"1/4x1"1/4*	0,64	1,46	2,52	6,70	14,10

**NOTE**

\*Tail pieces without self sealing - Brass caps.

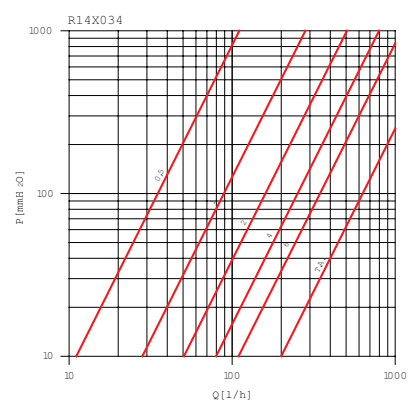
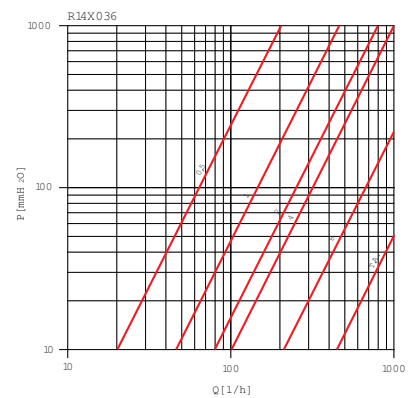
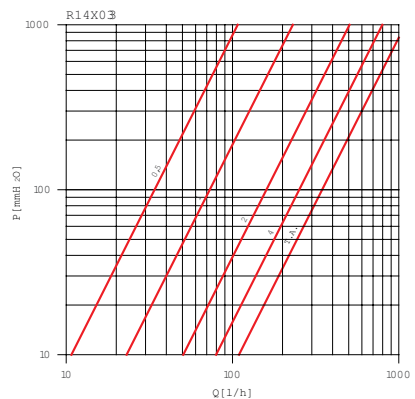
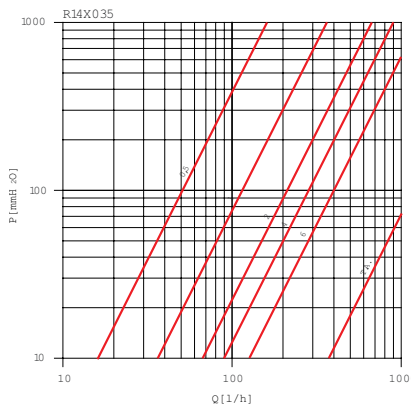
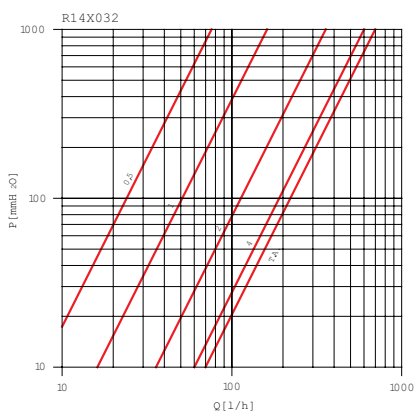

**R15TG**

Straight lockshield valve, chrome plated, with iron pipe connection.



PRODUCT CODE	SIZE	NUMBER OF OPENING TURNS				T.A.	
		0,5	1	2	4		
R15X032	3/8"x3/8"	0,21	0,46	0,89	0,98	-	1,33
R15X033	1/2"x1/2"	0,27	0,59	1,20	1,60	-	1,83
R15X034	3/4"x3/4"*	0,35	0,94	1,76	2,50	3,46	4,71
R15X035	1"x1"*	0,48	1,17	1,87	3,00	4,71	8,94
R15X036	1"1/4x1"1/4"*	0,70	2,00	4,42	8,16	9,48	11,20

**NOTE**

\*Tail pieces without self sealing - Brass caps.

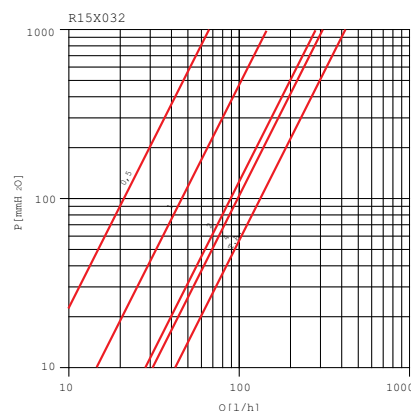

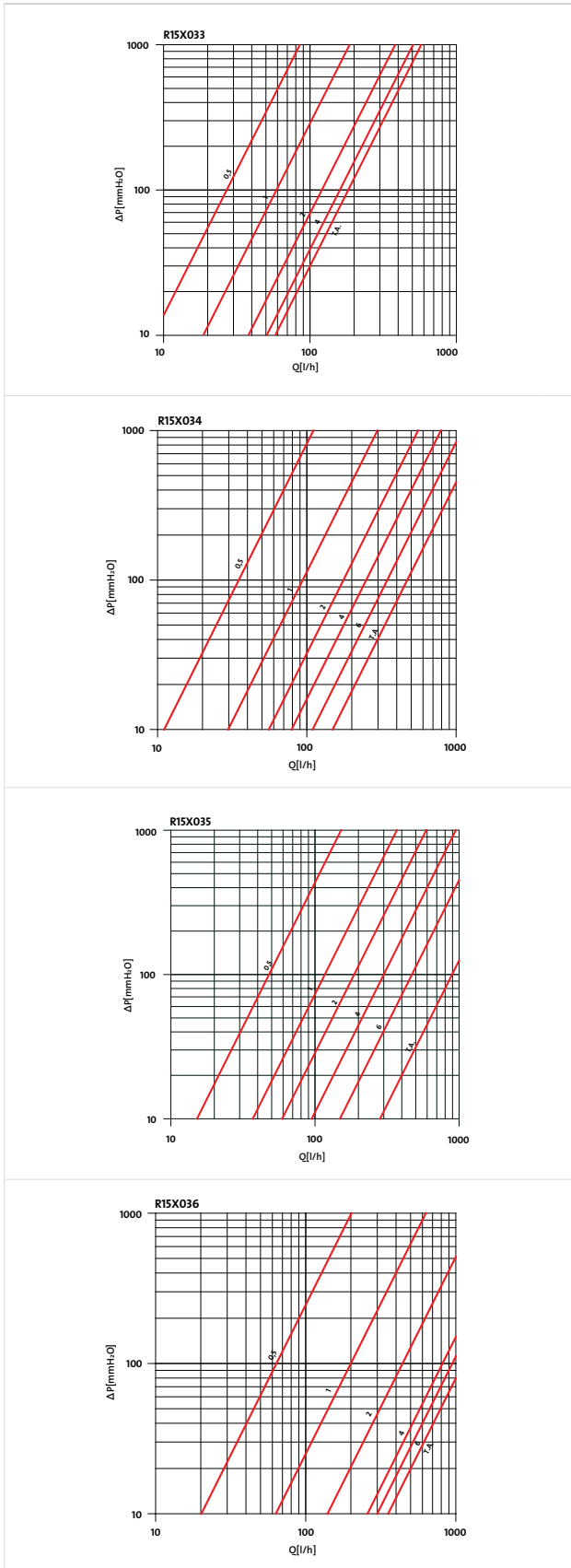

## Volumes and dimensions [mm]

### R29TG

\* Brass cap

PRODUCT CODE	GxB	H	I	J	L	Y*	W
R29X032	3/8"x16	47	53	21	70	-	30
R29X033	1/2"x16	47	53	21	70	-	30
R29X034	1/2"x18	50	54	24	71	-	30
R29X035*	3/4"x18	54	60	24	79	35	38
R29X036*	3/4"x22	61	60	31	79	35	38

### R31TG

\* Brass cap

PRODUCT CODE	GxB	H	I	J	L	Y*	W
R31X032	3/8"x16	51	52	17	75	-	30
R31X033	1/2"x16	51	52	17	76	-	30
R31X034	1/2"x18	51	52	17	77	-	30
R31X035*	3/4"x18	62	54	21	80	35	38
R31X036*	3/4"x22	62	54	21	84	35	38

### R14TG

\* Brass cap

PRODUCT CODE	GxB	H	I	J	K	L	Y*	W
R14X032	3/8"x3/8"	43	50	19	22	66	-	27
R14X033	1/2"x1/2"	47	53	21	26	70	-	30
R14X034*	3/4"x3/4"	54	60	23	32	79	35	38
R14X035*	1"x1"	72	68	30	39	90	40	46
R14X036*	1"1/4x1"1/4	80	80	34	49	108	45	53

### R15TG

\* Brass cap

PRODUCT CODE	GxB	H	I	J	K	L	Y*	W
R15X032	3/8"x3/8"	47	51	15	22	77	-	27
R15X033	1/2"x1/2"	51	52	17	26	76	-	30
R15X034*	3/4"x3/4"	62	55	21	32	81	35	38
R15X035*	1"x1"	78	69	26	39	106	40	46
R15X036*	1"1/4x1"1/4	86	78	30	49	119	45	53

\* Y measure of the operating key for the brass cap.  
Versions 3/8" and 1/2" are supplied with plastic cap

## ACCESSORIES AND SPARE PARTS

### Adaptors

Connection of copper pipes to the distribution systems / thermo-hydraulic regulation can be effected by using the following types of compression fittings.

Reference to latest price list is recommended to check available sizes and product codes for each picture.

### R178 - Compression connections for copper pipes

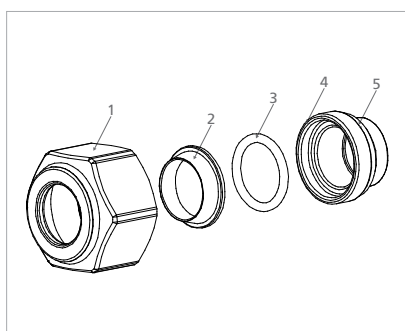

- 1 Nut
  - 2 mechanical sealing element
  - 3 internal o-ring
  - 4 adaptor \*
  - 5 external o-ring \*
- \*components not present in sizes 16x16, 18x18 e 22x22

#### Installation

1. The pipe must be cut perpendicularly to its axis and its external surface deburred.
2. Fit the nut on the pipe first, then the mechanical sealing element.
3. Lubrify the hydraulic sealing elements (this is essential to avoid the o-ring being damaged in the installation phase, which would compromise the effectiveness of the connection).
4. Install internal o-ring in the adaptor seat (when predisposed) or in the terminal of the thermo-hydraulic distribution/regulation system.
5. Insert pipe into the adaptor (when predisposed) or in the terminal of the thermo-hydraulic distribution/regulation system, until it stops against the same.
6. Proceed with tightening the nut to the terminal of the thermo-hydraulic distribution/regulation system.

### R178C - Raccordi a compressione compatti per tubi rame

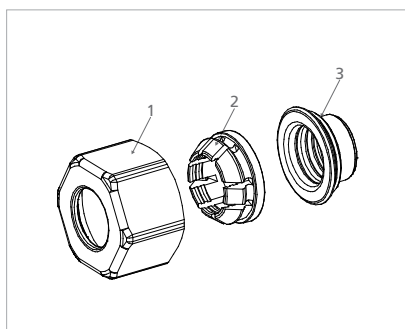

- 1 Nut
- 2 mechanical sealing element
- 3 idraulic sealing element

#### Installation

1. The pipe must be cut perpendicularly to its axis and its external surface deburred.
2. Fit the nut on the pipe first, then the mechanical sealing element.
3. Lubrify the hydraulic sealing elements (this is essential to avoid the o-ring being damaged in the installation phase, which would compromise the effectiveness of the connection).
4. Install the hydraulic sealing element in the seat of the terminal of the thermo-hydraulic distribution/regulation system.
5. Insert pipe into the terminal of the thermo-hydraulic distribution/regulation system, until it rests against the same.
6. Proceed with tightening the nut to the terminal of the thermo-hydraulic distribution/regulation system.

## R179AM - Compression fittings for synthetic or multilayer pipes

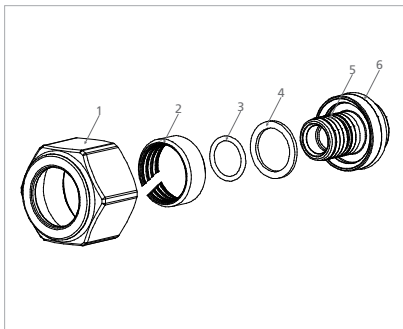

- 1 Nut
- 2 Mechanical sealing element
- 3 Internal o-ring
- 4 Spacer ring (R179AM only) compulsory for use with multilayer pipe
- 5 Adaptor and hose nozzle
- 6 External o-ring

### Installation

1. The pipe must be cut perpendicularly to its axis by means of the R990 pipe cutter (we recommend a slight rotation of the cutter during the operation, to facilitate cutting); in case of multilayer pipes, to limit ovalization, use the RP204 roller pipe cutter.
2. To prevent any damage to the hydraulic sealing elements during the installation phase and guarantee effectiveness of connection:
  - a. deburr internal surface of the pipe, using the special RP205 tool;
  - b. gauge the internal surface of the pipe, using the special RP209 tool (only in case of multilayer pipes);
  - c. lubricate both the hydraulic sealing elements and the internal surface of the pipe in contact with the internal o-ring.
3. Fit the spacer ring first (compulsory for use with multilayer tubes) and subsequently slide the pipe in the adaptor pipe slot, until it stops against the adaptor itself.
4. Position the adaptor in the terminal of the thermo-hydraulic distribution/regulation system by means of the external o-ring.
5. Proceed with tightening the nut to the terminal of the thermo-hydraulic distribution/regulation system.

When connecting multilayer pipes to the thermo-hydraulic distribution/regulation system, interposing the plastic spacer ring between the uncovered section of the pipe's metallic surface and the adaptor body prevents the occurring of electro-corrosive phenomena which could compromise the effectiveness of the connection.

## Self/sealing pipe union (in 3/8" and 1/2" sizes)

Always attentive to market needs, during long studies and tests at its technological laboratories Giacomini implemented also on the valves and radiator lockshields of the new Giacotech series (in 3/8" and 1/2" sizes) the notion of self/sealing. The presence of the tightness ring on the conical part of the union pipe allows making the installation without forcing the screwing of the union cap between the body and the union pipe. Following attentively some simple instructions you can quickly make functional long-life installations. The self-sealing pipe union by Giacomini is supplied already equipped with a tightness element in elastomeric material that prepares its assembly on the heating body without the use of hemp, paste or other tightness materials. For proper and fast assembly we recommend light lubrication of the threading before starting the screwing. The screwing phase should be carried out with specific R73 hexagonal Allen wrench (e.g. 9mm for 3/8" tail pices or 12 mm for 1/2"). Due to the presence of the tightness element in elastomeric material just apply a screwing torque not higher than 25 Nm.

## Tail pieces and nuts

**P15TG**  
Brilliant chrome plated tail piece.



PRODUCT CODE	SIZE
P15TGX002	3/8"
P15TGX003	1/2"x3/8"
P15TGX004	1/2"

**NOTE**  
P15TGX002 for versions with 3/8" iron connection  
P15TGX003 for versions with 3/8"x16 adaptor connection  
P15TGX004 for versions with 1/2"x16, 1/2"x18 adaptor connections and 1/2" iron connection. R436-1, R438-1, R438M-1.

**P15-2**  
Chrome plated tailpiece.



PRODUCT CODE	SIZE	NUT
P15X009	1/2"x3/8"	P18LX009
P15X002	3/8"	P18LX002
P15X003	1/2"	P18LX003
P15X004	3/4"*	P18LX004
P15X005	1"*	P18LX005
P15X006	1"1/4*	P18LX006

**R18L**  
Nut for straight fittings.



CROMATO	
PRODUCT CODE	SIZE
P18LX002	5/8"x3/8"
P18LX003	3/4"x1/2"
P18LX004	1"x3/4"
P18LX005	1"1/4x1"
P18LX006	1"1/2x1"1/4

## Chrome-plated telescopic pipe union

In order to facilitate the operations of systems refurbishing the R173 telescopic extensible pipe unions with R173TG self-sealing. The variable length of the pipe union according to installation needs allows saving a lot of time and avoiding the need of extensions, obtaining anyway a simple and reliable assembly. This solution in addition allows compensating very easily any thermal expansions.

PRODUCT CODE	G	Lmin	Lmax	COMPATIBILITY	NUT
R173X002	3/8"	31	47	Valves and lockshields 3/8" iron connection	P18LX002
R173X007	3/8"	31	47	Valves and lockshields 3/8" x 16	P18LX003
R173X003	1/2"	34	50	Valves and lockshields 1/2" x 16 - 1/2" x 18 - 1/2" x 12"	P18LX002
R173X004	3/4"	38	57	Valves and lockshields 3/4" x 18 - 3/4" x 22 - 3/4" x 3/4"	P18LX004
R173X005	1"	42	63	Valves and lockshields 1" x 1"	P18LX005
R173X006	1"1/4	50	74	Valves and lockshields 1"1/4 x 1"1/4	P18LX006

PRODUCT CODE	G	Lmin	Lmax	Lmax	COMPATIBILITY	NUT
R173X032	3/8"	37	53	57	Valves and lockshields iron connection 3/8"	P18LX002
R173X037	3/8"	37	53	58	Valves and lockshields 3/8" x 16	P18LX003
R173X033	1/2"	38	54	58	Valves and lockshields 1/2" x 16 - 1/2" x 18 - 1/2" x 12"	P18LX002

\*L<sub>max</sub>: max. lenght with nut included

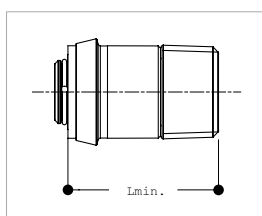
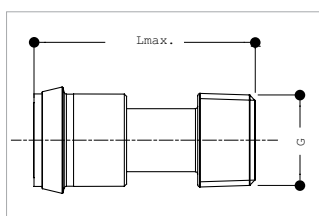

## Thermostatic head

Thanks to the exclusive CLIP CLAP fastening system, mounting Giacomini thermostatic heads on Giacomini micrometric thermostatic valves can be carried out very easily by simply removing the R450TG manual handwheel with the aid of a screwdriver.

**R460**  
Thermostatic head with liquid sensor, with anti-freeze protection position.

PRODUCT CODE  
**R460X001**



CERTIFICATION AND SYMBOLS



**R470**  
Thermostatic head with liquid sensor, with anti-freeze protection position.

PRODUCT CODE  
**R470X001**



CERTIFICATION AND SYMBOLS

**R468C**  
Thermostatic head with liquid sensor, with anti-freeze protection position.

PRODUCT CODE  
**R468CX001**

CERTIFICATION AND SYMBOLS

**R468**  
Thermostatic head with liquid sensor, with anti-freeze protection position.

PRODUCT CODE  
**R468X001**

CERTIFICATION AND SYMBOLS



### TELL label

R460 and R468C thermostatic heads obtained the TELL label (Thermostatic Efficiency Label) in the class A of energy efficiency. TELL is an European classification system, applicable to thermostatic radiator valves, and it has been thought to inform and guide the consumers towards conscious purchase decisions and a responsible use of the energy. TELL classification criteria for thermostatic heads include the following merit factors:

- Influence of water temperature
- Hysteresis
- Response time
- Influence of differential pressure

**R462**  
Thermostatic head with remote sensor and setting on the valve, with anti-freeze protection position.

\* until stocks are axhausted

PRODUCT CODE	SIZE
<b>R462X002</b>	2 m
<b>R462X005</b>	5 m
<b>R462X010 *</b>	10 m
<b>R462X015 *</b>	15 m



**R463**  
Comando termostatico con sensore e regolatore entrambi a distanza, con position per protezione antigelo.

\* until stocks are axhausted

PRODUCT CODE	SIZE
<b>R463X002</b>	2 m
<b>R463X005</b>	5 m
<b>R463X010 *</b>	10 m
<b>R463X015 *</b>	15 m



TELL R460: reg.no. 10440-20120312 (valid up to 2016)

**TELL**  
Thermostatic Efficiency Label

Manufacturer: **Giacomini**  
Model: **R460**  
Registration number: **10440-20120312**



Information: [www.tell-online.eu](http://www.tell-online.eu)

A Label of EUnited Valves  
European Valve Manufacturers Association

TELL R468: reg.no. 10544-20131009 (valid up to 2017)

**TELL**  
Thermostatic Efficiency Label

Manufacturer: **Giacomini S.p.A.**  
Model: **R468**  
Registration number: **10544-20131009**



Information: [www.tell-online.eu](http://www.tell-online.eu)

A Label of EUnited Valves  
European Valve Manufacturers Association

TELL R468C: reg.no. 10531-20140616 (valid up to 2018)

**TELL**  
Thermostatic Efficiency Label

Manufacturer: **Giacomini SpA**  
Model: **R468C**  
Registration number: **10531-20140616**



Information: [www.tell-online.eu](http://www.tell-online.eu)

A Label of EUnited Valves  
European Valve Manufacturers Association



## Handwheels and caps

**R450TG**



Micrometric handwheel for valves with thermostatic option of GIACOTECH series.

PRODUCT CODE	
R450X012	

**P26A**



Chrome plated cap for lockshield valves.

PRODUCT CODE	SIZE
P26AX004	3/4"
P26AX005	1"
P26AX006	1 1/4"

**P22B-1**



Handwheel for single adjustment valves, for R5A, R6A, R25A, R27A.

PRODUCT CODE	SIZE
P22BY007	3/8"-1/2"
P22BY008	3/4"-1"
P22BY009	1 1/4"

**P26PD**



Plastic cap for lockshield valves.

PRODUCT CODE	SIZE
P26PX012	3/8"
P26PX013	1/2"

**NOTE**

P26PY012: for 3/8" iron connection versions.  
 P26PDY013: for 1/2" iron connection and 3/8"x16, 1/2"x16 and 1/2" x 18 adaptor connection versions.

## Bonnets

**P12A**



TRV bonnet.

PRODUCT CODE	SIZE
P12AX011	3/8"-1/2"3/4"
P12AX012	3/4"
P12AX003	1"
P12AX005	1/2"

**NOTE**

P12AX012: for valves R401, R402 da 3/4" with KEYMARK certification  
 P12AX005: for valves R415, R435

**R79B**



Key for tail pieces from 3/8" to 1 1/4", except P15TGX003.

PRODUCT CODE	
R79BY001	

**R400**



Special tool to replace the bonnet of any thermostatic valve without draining the system.

PRODUCT CODE	
R400X001	

**R73**



Tail piece Allen key.

PRODUCT CODE	SIZE
R73X009	ex. 9
R73X010	ex. 10
R73X012	ex. 12
R73X013	ex. 13

**NOTE**

ex. 9-10 for 3/8"  
 ex. 12-13 for 1/2" and P15TGX003

**R79A**



Tail piece key, except P15TGX003.

PRODUCT CODE	
R79AY021	

**R131**



Spanner.

PRODUCT CODE	SIZE
R131X002	27/27
R131X003	27/29
R131X004	29/30

**NOTE**

27/27: for base 16 adaptors.  
 27/29: for base 16 and 18 adaptors and 3/8" tail piece nuts.  
 29/30: for base 18 adaptors and 1/2" tail piece nuts.





This document is just an indication. Giacomini S.p.A. reserves the right of making at any moment, without prior notice, modifications for technical or commercial reasons to the items contained in this document. The information contained in this technical communication does not exempt the user from strictly following the existing regulations and good practice rules. Prior written permission of the management is required for any partial or total reproduction of the contents.



**GIACOMINI**  
WATER E-MOTION

Via per Alzo, 39  
I-28017 San Maurizio d'Opaglio (NO)  
tel (+39) 0322 923111  
fax (+39) 0322 96256  
[info@giacomini.com](mailto:info@giacomini.com)